



# PRODUCT CATALOG

For North America Market



illuminating the world with superior quality

## Guang Dong HOSO lighting technology .ltd

地址：广东省中山市横栏镇中创云谷智能产业城w栋  
building W, Zhong chuang yungu, Huan town North Road, henglan Town. Zhongshan City, Guang Dong

TEL:18666180116 Wechat: PuHaiKangLED

Webi:<https://gdhosolighting.com/>

Email:sales001@hosolighting.cn

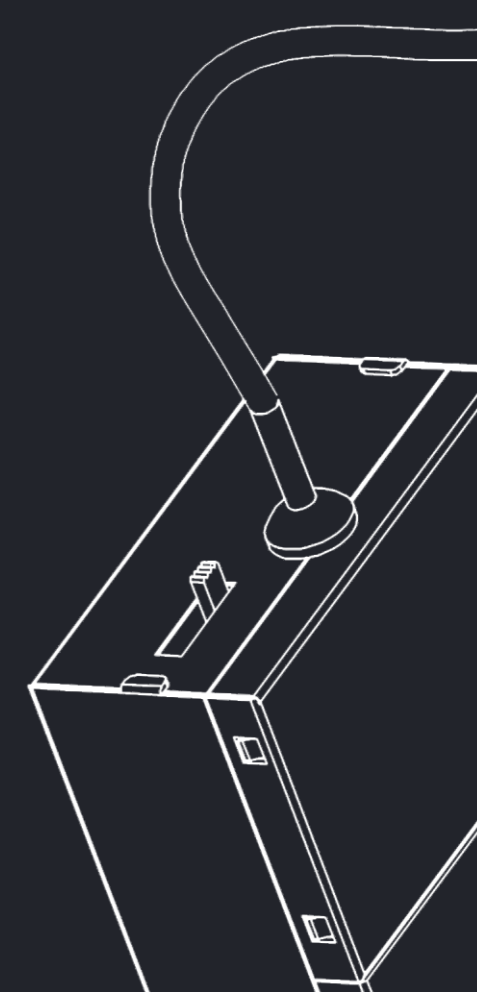



## 公司简介

广东鸿烁照明有限公司成立于2014年，坐落于广东，泰国。拥有两地工厂，占地面积30000多平方米，员工人数为450余人，作为专业的LED面板灯，LED筒灯产品供应商，我们拥有压铸，注塑，切割，贴片，喷粉等多个车间，全供应链体系，为了向客户提供满意的产品和服务，根据国际标准，我们建立了一套现代化的质量管理体系，我们有无尘车间，IES测试设备，多功能老化架等设备来严格控制产品的质量，我司员工经验丰富，并致力于严格质检和周到客服，并能随时讨论客户需求保证客户满意度。公司主营北美面板灯、筒灯、无边框面板灯、智能灯具、户外灯具等一系列产品，畅销于美洲，欧洲，中东，亚洲等市场。并获得CE, CB, rohs, etlfcc, tuv证书。同时，我们也承接OEM和ODM订单，我们坚持互惠互利原则，并在我们的客户中享有良好声誉，因为我们提供专业的服务，高质量的产品以及有竞争力的价格。无论贵司是我们现有目录中选取一款产品或是要寻求工程应用方面的帮助，欢迎随时联系我司客服中心，并告之贵司的采购要求。热忱欢迎国内外客户和我们合作来获得共同的成功。

Guangdong Hosho Lighting Co., Ltd. was established in 2014 and is located in Guangdong, Thailand. We have two factories covering an area of over 30000 square meters with more than 450 employees. As a professional supplier of LED panel lights and LED tube lights, we have multiple workshops including die-casting, injection molding, cutting, surface mounting, and powder coating, with a full supply chain system. In order to provide customers with satisfactory products and services, we have established a modern quality management system according to international standards. We have dust-free workshops, IES testing equipment, multi-functional aging racks and other equipment to strictly control the quality of our products. Our experienced employees are committed to strict quality inspection and thoughtful customer service, and can discuss customer needs at any time to ensure customer satisfaction. The company's main products include North American panel lights, tube lights, frameless panel lights, smart lighting fixtures, outdoor lighting fixtures, etc., which are sold well in markets such as the Americas, Europe, the Middle East, and Asia. And obtain CE, CB, RoHS, ETLFCC, and TUV certificates. At the same time, we also undertake OEM and ODM orders. We adhere to the principle of mutual benefit and enjoy a good reputation among our customers because we provide professional services, high-quality products, and competitive prices. Whether your company selects a product from our existing catalog or seeks assistance in engineering applications, please feel free to contact our customer service center at any time and inform us of your purchasing requirements. We warmly welcome domestic and foreign customers to cooperate with us to achieve common success.

## Factory Scene: Workshop



## Factory Scene: Quality Control



External environment of the factory in Thailand



Internal environment of the factory in Thailand

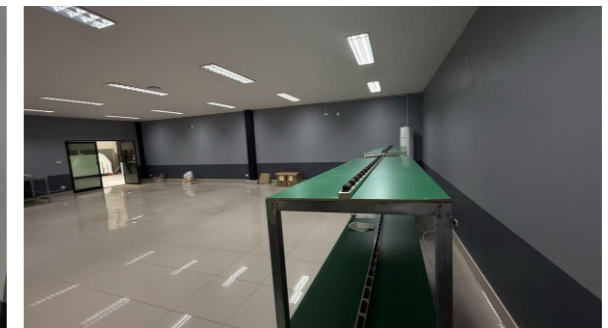
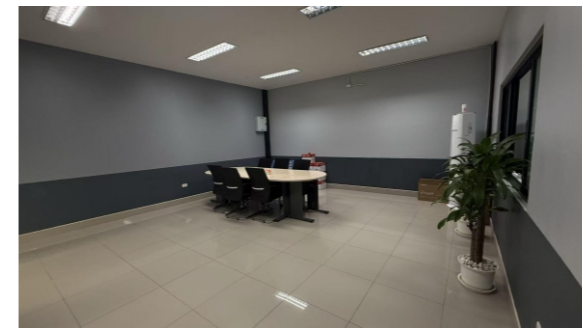
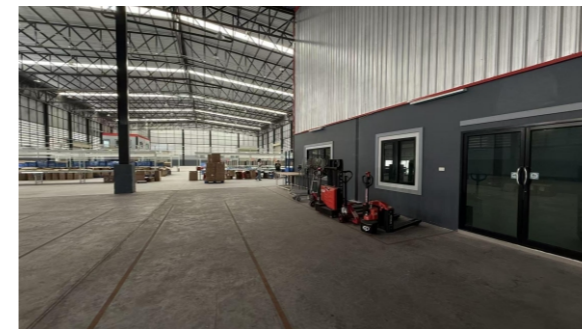

# Product Certificate: ETL

# PRODUCT CATALOG

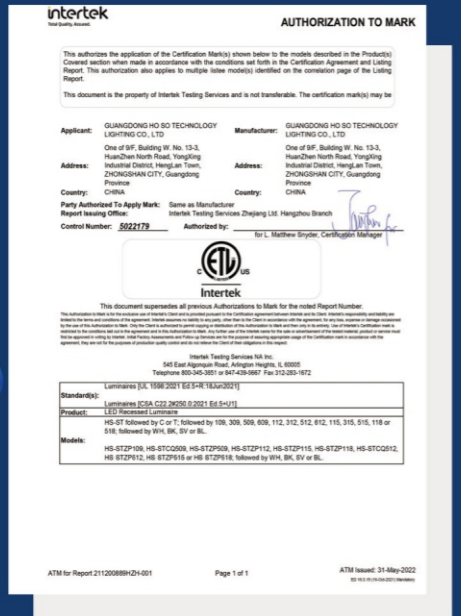
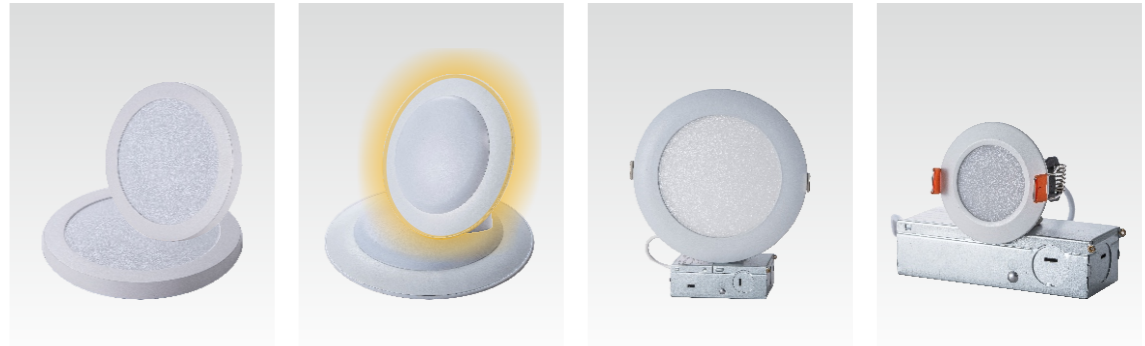
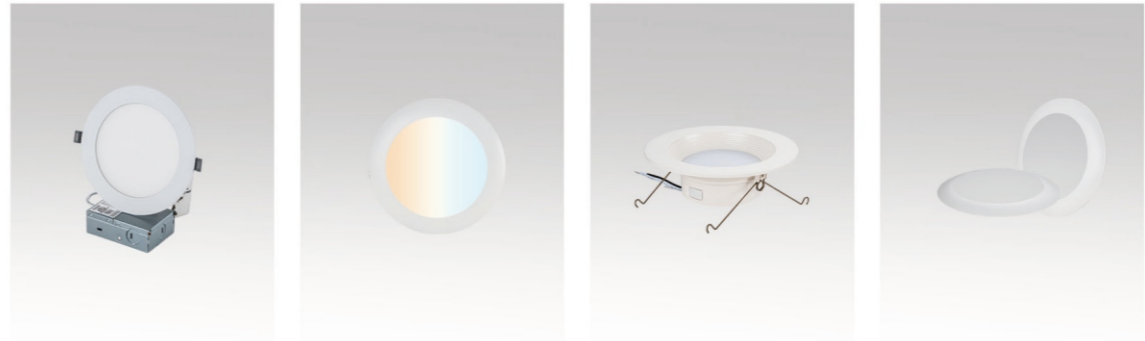

## HS PANEL LAMP



- \*120 beam angle
- \*delivered CRI 80/90
- \*up to 90lm/w
- \*5 Years warranty
- \*smooth dimming



## SIZE & MODELS

6"  
940lumens



## COLOR TEMPERATURE

RGB/6CCT /5CCT/3CCT/Single

\*Available in a 110-130V  
option (0-10v dim)



## Easy Installation

Each unit includes a junction box with driver, pressure-fit spring clips and Quick Connect wire connectors for fast and easy installation.



## Heavy Duty Mounting Clips

Heavy duty mounting clips are designed for sturdy installation and prevent springs from falling off during installation.

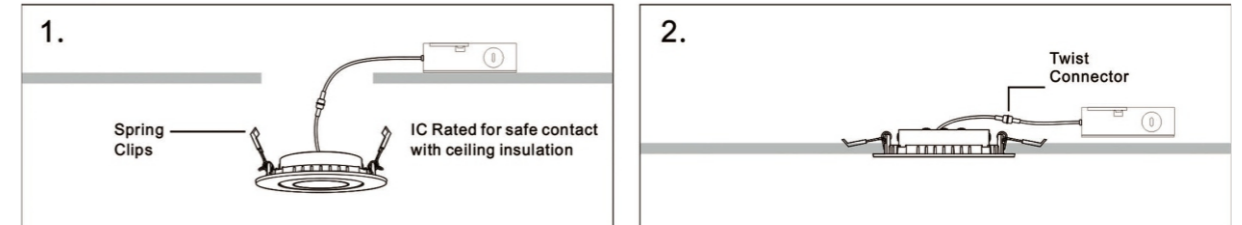

MODEL-NO	HS-A-AY-ETL-O15RGB
Watt	15W
Size	170mm
Cut out	158mm
Input Voltage	110-130V
PF	>0.9
Dimmable	triac-dimmable 3/5cct
Certification	ETL/FCC
LED	SMD2835
Lumen	850 Lm
CCT	RGB
CRI	>80/>90

## HS-AC-PLASTIC PANEL LAMP



- \*120 beam angle
- \*delivered CRI 80/90
- \*up to 90lm/w
- \*5 Years warranty
- \*smooth dimming



## SIZE & MODELS

3"	4"	6"	8"
460lumens	750lumens	940lumens	1530lumens



## COLOR TEMPERATURE

6CCT / 5CCT / 3CCT / Single

\*Available in a 110-130V option (0-10v dim)



## Easy Installation

Each unit includes a junction box with driver, pressure-fit spring clips and Quick Connect wire connectors for fast and easy installation.

## Heavy Duty Mounting Clips

Heavy duty mounting clips are designed for sturdy installation and prevent springs from falling off during installation.

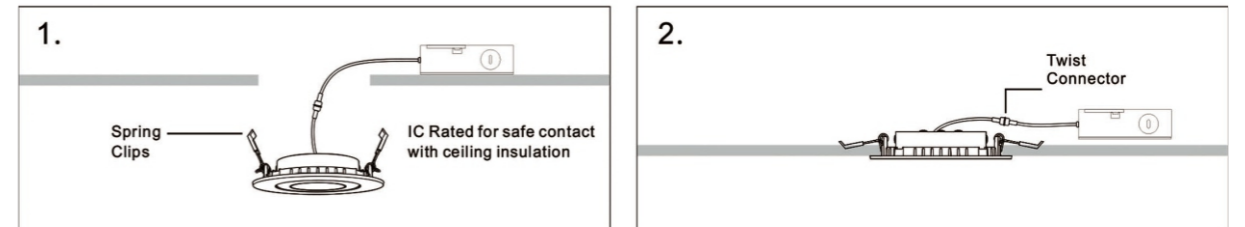

MODEL-NO	HS-A-AY-ETL-007	HS-A-AY-ETL-009	HS-A-AY-ETL-012	HS-A-AY-ETL-015	HS-A-AY-ETL-018
Watt	7W	9W	12W	15W	18W
Size	85mm	120mm	170mm	170mm	220mm
Cut out	62mm	105mm 4inch	155mm 6inch	155mm 6inch	205mm 8inch
Input Voltage	110-130v	110-130v	110-130v	110-130v	110-130v
PF	>0.9	>0.9	>0.9	>0.9	>0.9
Dimmable	Tri-ac dimmable(3/5CCT)	Tri-ac dimmable(3/5CCT)	Tri-ac dimmable(3/5CCT)	Tri-ac dimmable(3/5CCT)	Tri-ac dimmable(3/5CCT)
Certincation	ETL/ES/FCC/T24	ETL/ES/FCC/T24	ETL/ES/FCC/T24	ETL/ES/FCC/T24	ETL/ES/FCC/T24
LED	SMD2835	SMD2835	SMD2835	SMD2835	SMD2835
Lumen	360lm	750lm	1000lm	1300lm	1500lm
CCT	Dip switch 5CCT / Single cct (2700-6500k)				
CRI	>80 / >90				

## HS-AC-PLASTIC PANEL LAMP



- \*120 beam angle
- \*delivered CRI 80/90
- \*up to 90lm/w
- \*5 Years warranty
- \*smooth dimming



## SIZE & MODELS

4"	6"
750lumens	1000lumens



## COLOR TEMPERATURE

6CCT / 5CCT / 3CCT / Single

\*Available in a 110-130V option (0-10v dim)



## Easy Installation

Each unit includes a junction box with driver, pressure-fit spring clips and Quick Connect wire connectors for fast and easy installation. Fully plastic ultra-thin panel light easy to install.

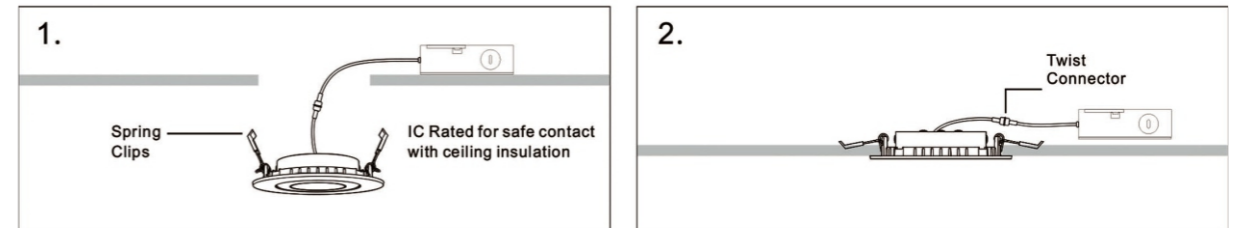

MODEL-NO	HS-AC-AY-ETL-009	HS-AC-AY-ETL-012
Watt	9w	12w
Size	120mm	175mm
Cut out	105mm 4inch	155mm 6inch
Input Voltage	110-130v	110-130v
PF	>0.9	>0.9
Dimmable	Tri-ac dimmable(3/5CCT)	Tri-ac dimmable(3/5CCT)
Certincation	ETL/ES/FCC/CEC	ETL/ES/FCC/CEC
LED	SMD2835	SMD2835
Lumen	750lm	1000lm
CCT	Dip switch 5CCT / Single cct (2700-6500k)	
CRI	>80 / >90	

## HS-A night light



White

\* Our These LED drop ceiling lights are certified by ETL Experience superior quality performance, and safety backed by a 5-year warranty

The entire lamp is made of PC material to ensure that the product meets the standards of safety, durability, and environmental protection

## SIZE & MODELS

4"	6"
750lumens	1000lumens

## COLOR TEMPERATURE

5CCT / With night light

\*Available in a 110-130V

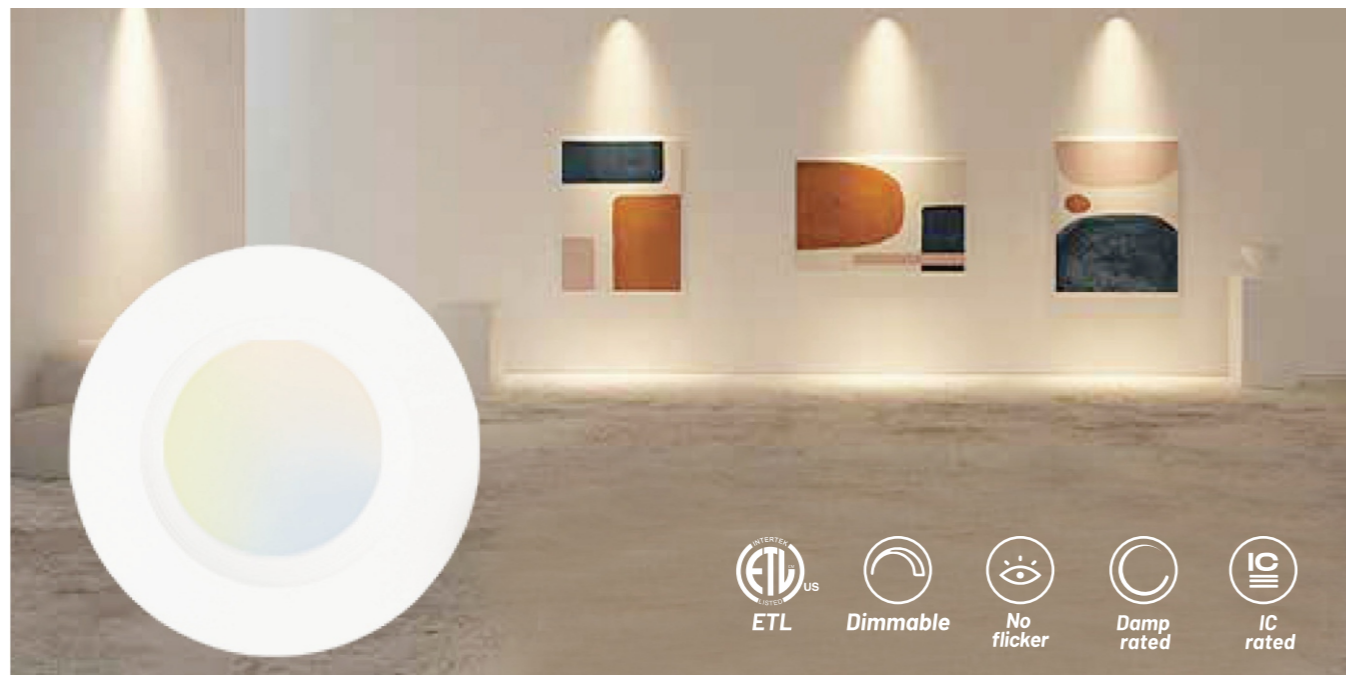

## super Easy Installation

Standard E26 base allows you to easily screw into the can

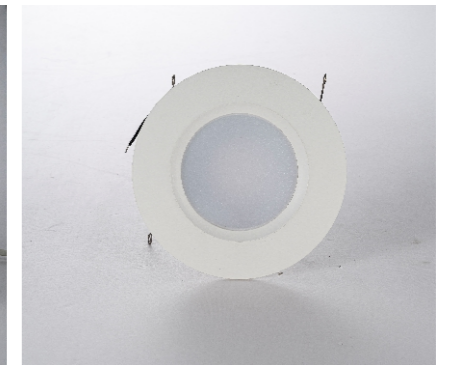
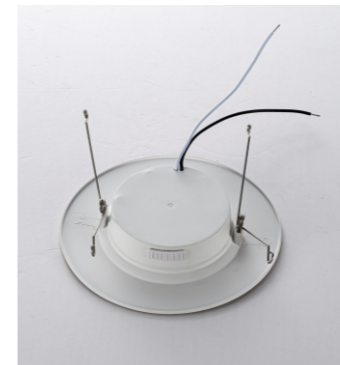
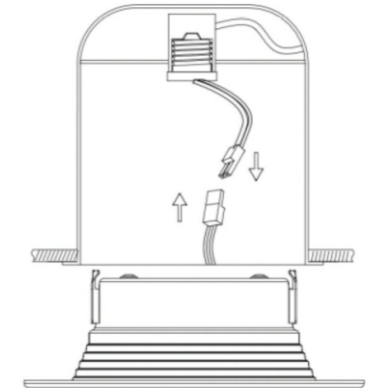

MODEL-NO	HS-AH-AY-ETL-008	HS-AH-AY-ETL-012
Watt	8W	11W
Size	152mm	186mm
Cut out	/	/
Input Voltage	110-130V	110-130V
PF	>0.9	>0.9
Dimmable	triac-dimmable3/5cct	triac-dimmable3/5cct
Certincation	ETL/FCC	ETL/FCC
LED	SMD2835	SMD2835
Lumen	654 Lm	960 Lm
CCT	Dip-switch5cct/single cct (2700-5000k)	
CRI	>80	

## HS-AO DISK LIGHT



- \*Surface mounted / retrofit
- \* Ceiling light

**\*Durable Material that is Built to Last**  
This Dimmable LED Flush Mount Disk Light is fitted with PC plastic lens. Equipped with a high quality LED chip, this disk light is designed for long-term use.

## SIZE & MODELS

4"	6"
650lumens	1100lumens

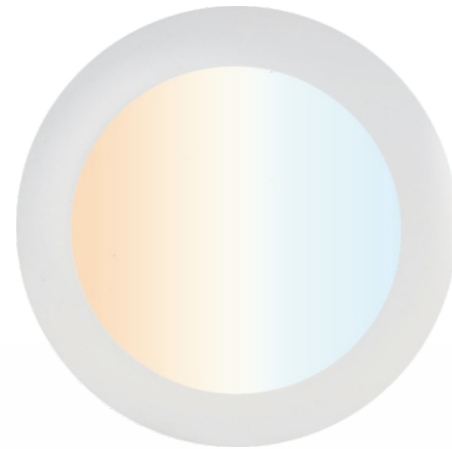

## COLOR TEMPERATURE

5CCT / 3CCT / Single

\*Available in a 110-130V option (0-10v dim)

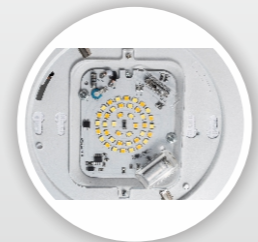
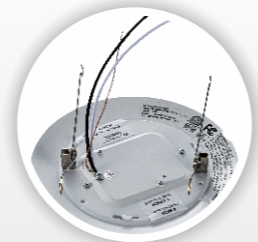

## Easy Installation

Recessed / Surface / Can Installation

### Option 1: Junction Box

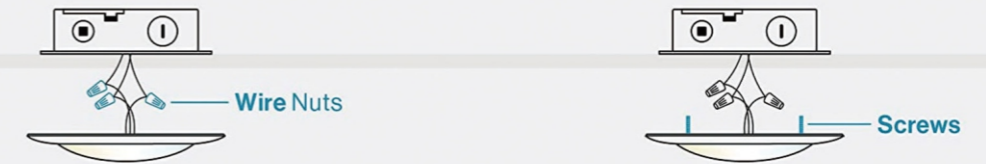

### Option 2: Recessed Can (TP24)

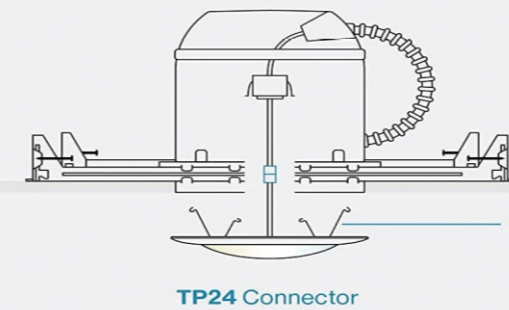

### Option 3: Recessed Can (E26)

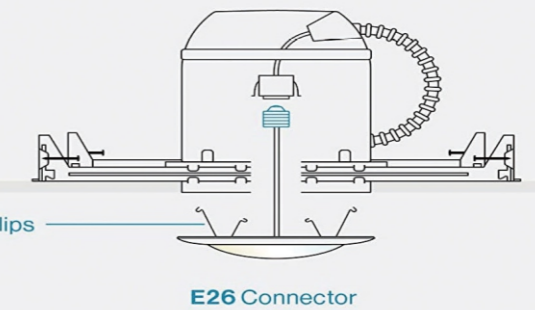

MODEL-NO	HS-AO-AY-ETL-015
Watt	15W
Size	186mm
Cut out	/
Input Voltage	110-130V
PF	>0.9
Dimmable	triac-dimmable3/5cct
Certincation	ETL/FCC
LED	SMD2835
Lumen	850 Lm
CCT	Dip-switch5cct/single cct(2700-5000k)
CRI	>80/>90

## HS-AJ Eveball Canless Slim Panel Lights

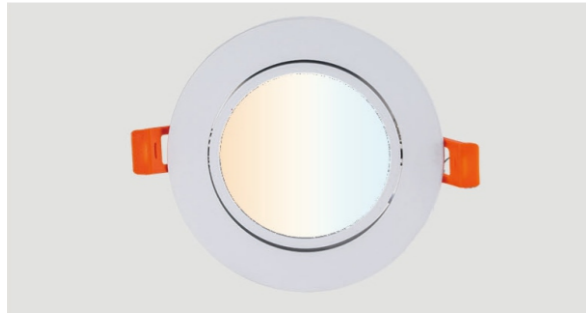

### SIZE & MODELS

3"	6"
600lumens	1100lumens

### COLOR TEMPERATURE

5CCT

GIMBAL LED

SLIM PANEL LIGHT

- ULTRA-THIN SLIM DESIGN
- NO RECESSED CAN REQUIRED
- JUNCTION-BOX INCLUDED



**\*ADJUSTABLE**

**LIGHT DIRECTION**

\*180° OF SWIVEL TO EITHER SIDE The gimbal feature allows you to adjust the light to any direction or angle you prefer

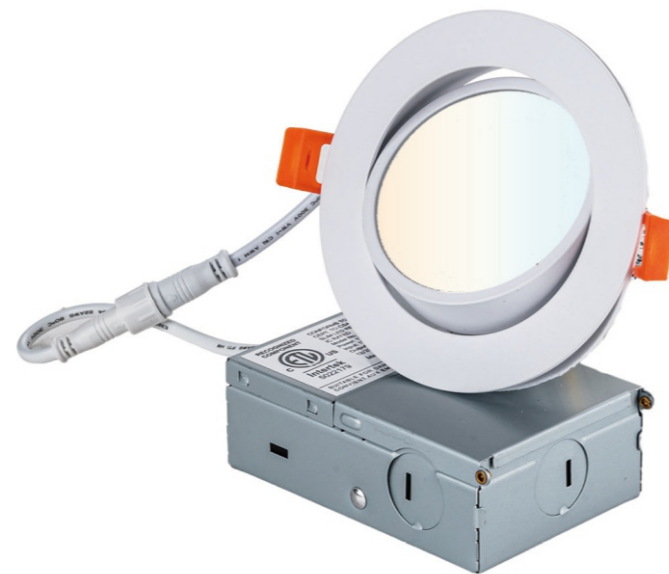

**super Easy Installation**

No need to install a fire drum, easy to install

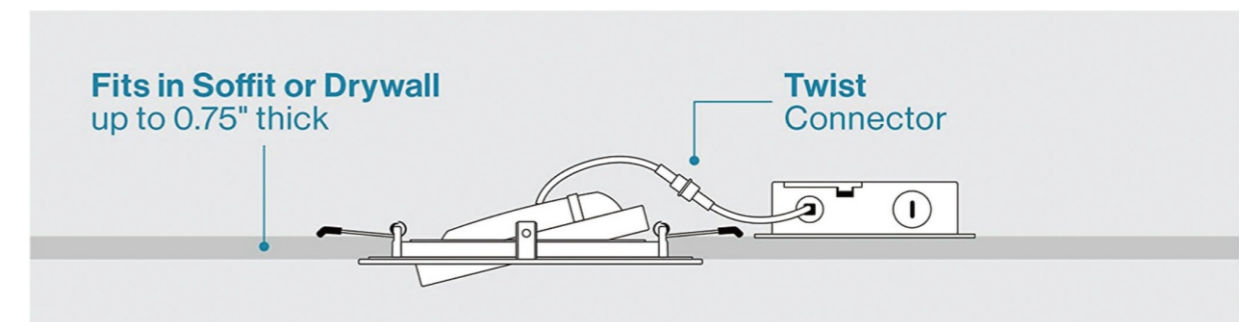
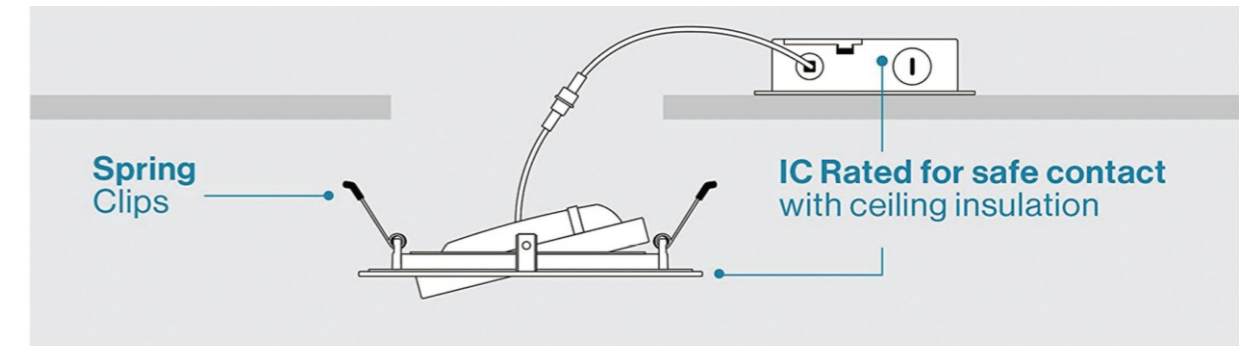

MODEL-NO	HS-AJ-AY-ETL-007	HS-AJ-AY-ETL-012
Watt	7w	12w
Size	85mm	170mm
Cut out	65mm 2.5"	155mm 5/6"
Input Voltage	110-130V	110-130V
PF	>0.9	>0.9
Dimmable	Tri-ac dimmable	Tri-ac dimmable
Certification	ETL/FCC/ES	ETL/FCC/ES
LED	SMD2835	SMD2835
Lumen	600lm	600lm
CCT	Dip switch 5CCT/ Single cct (2700-6500k)	Dip switch 5CCT/ Single cct (2700-6500k)
CRI	>80/>90	>80/>90

## HS-A night light



- \* Unique smooth design with 2 channel light
- \* Brightness nightlight with soft performance
- \* Comfortable cost



5CCT / With night light

\* Available in a 110-130V

## SIZE & MODELS

4"	6"
750lumens	1100lumens



## Aluminum LED Retrofit Down Light

### super Easy Installation

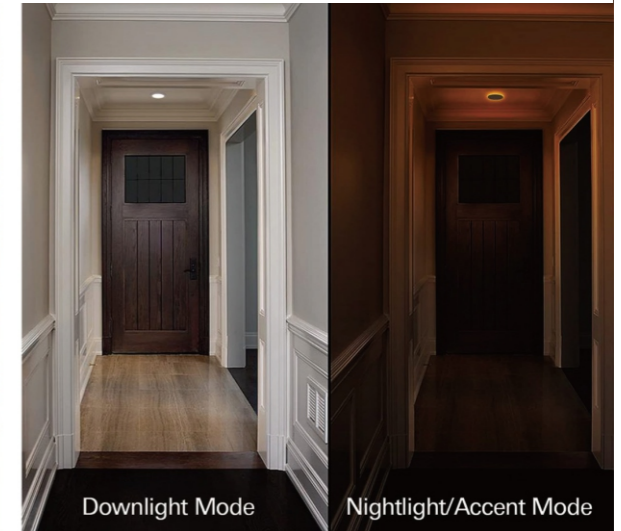
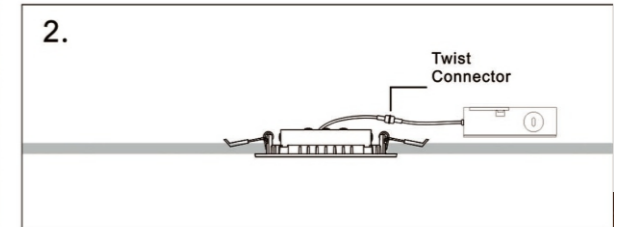
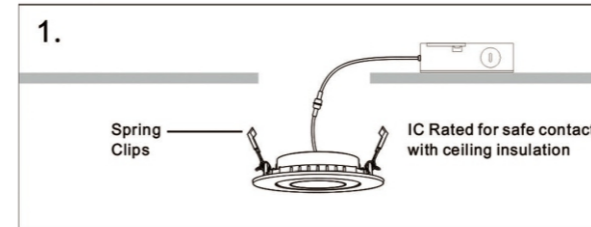

MODEL-NO	HS-AN-AY-ETL-009+3	HS-AN-AY-ETL-012+4
Watt	9w+3W Nightlight	12W+4W Nightlight
Size	140mm	170mm
Cut out	105mm 4inch	155mm 5-6inch
Input Voltage	110-130V	110-130V
PF	>0.7	>0.7
Dimmable	Tri-ac dimmable	Tri-ac dimmable
Certincation	ETL/ES/FCC/T20	ETL/ES/FCC/T20
LED	SMD2835	SMD2835
Lumen	750lm	1100lm
CCT	DIP Switch 5CCT+2000K nightlight	
CRI	>80 / >90	

## HS-AJ- Gimbal Eyeball slim Downlight

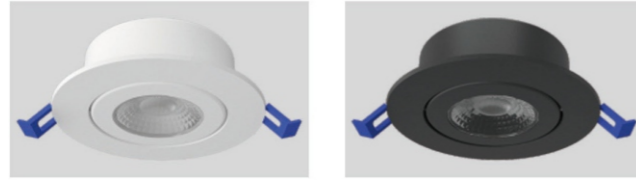

White

Black

Smooth dimming capabilities ranging from 10% to 100% with modern LED dimmers allow you to control the look and feel of your space. Easy Installation, each unit includes a junction box with driver.



## SIZE & MODELS

4"  
750lumens

## COLOR TEMPERATURE

5CCT / 3CCT / Single night light

\*Available in a 110-130V  
option (0-10v dim)



## Easy Installation

each unit includes a junction box with driver.

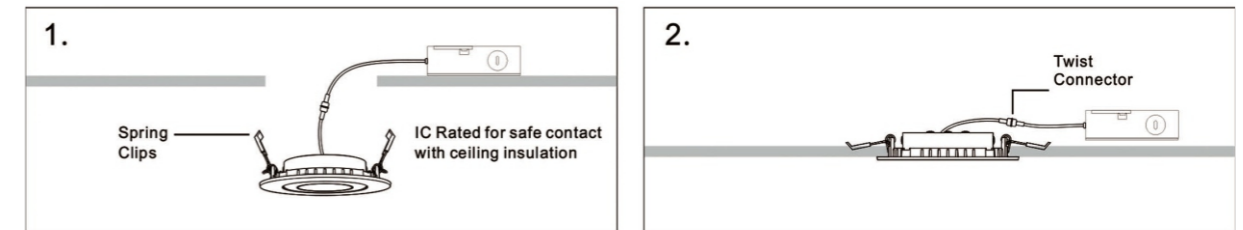

## wide Application

Garage, Kitchen, Bedroom, Hallway

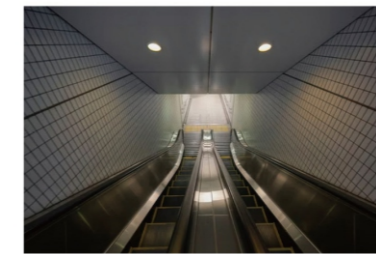
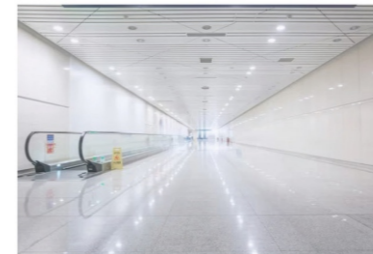

MODEL-NO	HS-AJ-AY-ETL-009
Watt	9w
Size	120mm105mm 4inch
Cut out	110-130v
Input Voltage	>0.9
PF	Tri-ac dimmable(3/5CCT)
Dimmable	ETL/ES/FCC/T24
Certincation	cob
LED	750lm
Lumen	Dip switch 5CCT / Single cct (2700-6500k)
CCT	80 />90
CRI	

## HS-Ab-360°eyeball canless slim panel



- \* Air tight
- \* Super wide-angle rotation
- \* Optical lens

## SIZE & MODELS

4"	6"
750lumens	1000lumens

## COLOR TEMPERATURE

5CCT / 3CCT / Single night light

\* Available in a 110-130V option (0-10v dim)

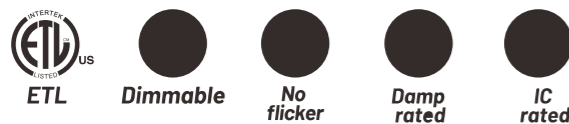
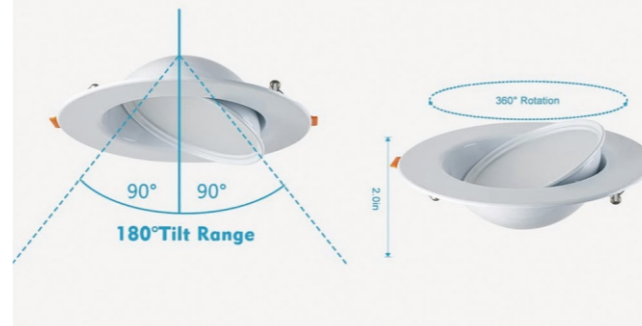
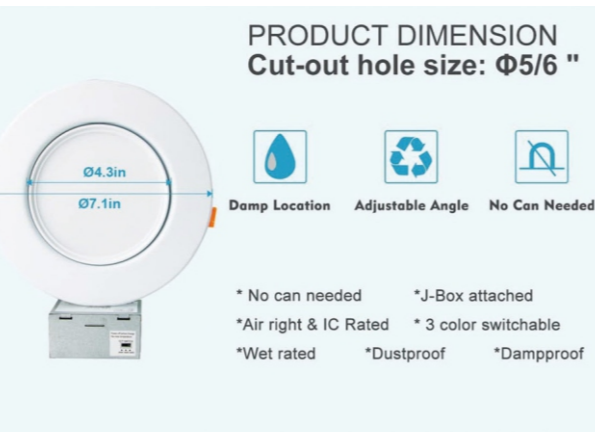

**Smooth Dimmability and Eye Caring**  
Seamless and smooth dimming capabilities from 10% to 100% that fit any mood or decor

## wide Application

Ideal for the living room, bedrooms, kitchen, hallway, basement, office

## Installation

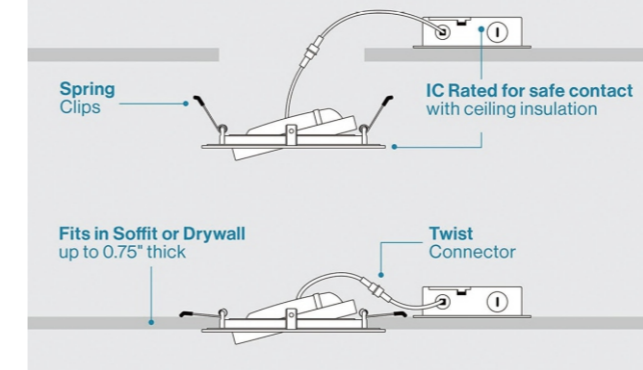

MODEL-NO	HS-Ab-AY-ETL-006	HS-Ab-AY-ETL-009
Watt	6w	9w
Size	95mm	128mm
Cut out	72mm 3inch	105mm 4inch
Input Voltage	110-130v	110-130v
PF	>0.9	>0.9
Dimmable	Tri-ac dimmable(3/5CCT)	Tri-ac dimmable(3/5CCT)
Certincation	ETL/ES/FCC/T24	ETL/ES/FCC/T24
LED	cob	cob
Lumen	400lm	400lm
CCT	Dip switch 5CCT / Single cct (2700-6500k)	
CRI	80 / >90	

## HS-XD PANEL LAMP

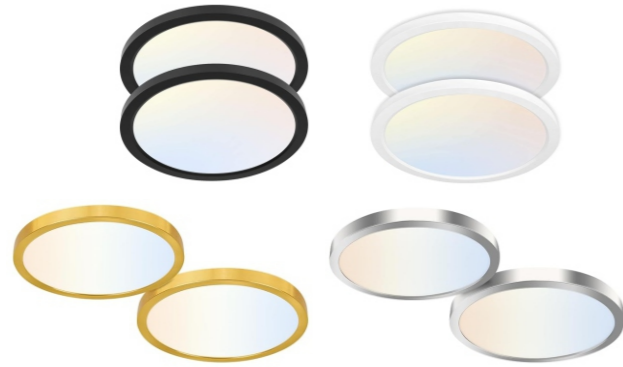

12 Inch LED Flush Mount Ceiling  
Light Fixture with Night Light, 24W,  
2600lm, 3K/5K CCT, Dimmable  
Round Modern Ceiling Light

## SIZE & MODELS

12"  
1850lumens

## COLOR TEMPERATURE

5CCT / 3CCT / Single

\*Available in a 110-130V  
option (0-10v dim)



## Optional Color Temperature

1800K+3000K-6500K



## Easy Installation

Recessed / Surface / Can Installation

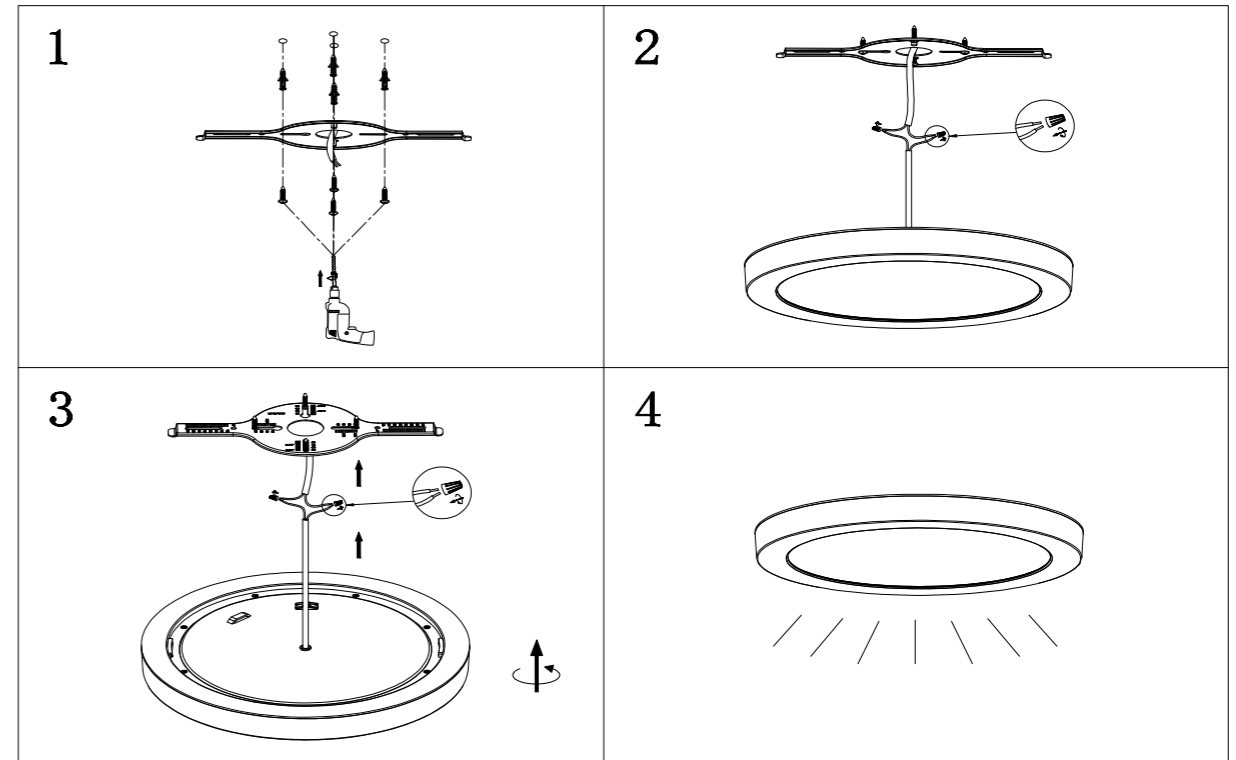

MODEL-NO	HS-XD-018	HS-XD-024	HS-XD-024+6	HS-XD-033
Watt	18W	24W	24+6W	33W
Size	220mm	300mm	298mm	400mm
Cut out	/	/	/	/
Input Voltage	110-130V	110-130V	110-130V	110-130V
PF	>0.9	>0.9	>0.9	>0.9
Dimmable	triac-dimmable3/5cct			
Certincation	ETL/FCC	ETL/FCC	ETL/FCC	ETL/FCC
LED	SMD2835	SMD2835	SMD2835	SMD2835
Lumen	1510 Lm	2050 Lm	2050 Lm	2957Lm
CCT	Dip-switch5cct/single cct(2700-5000k)			
CRI	>80/>90	>80/>90	>80/>90+70	>80/>90

## HS-AO DISK LIGHT NIGHT LIGHT

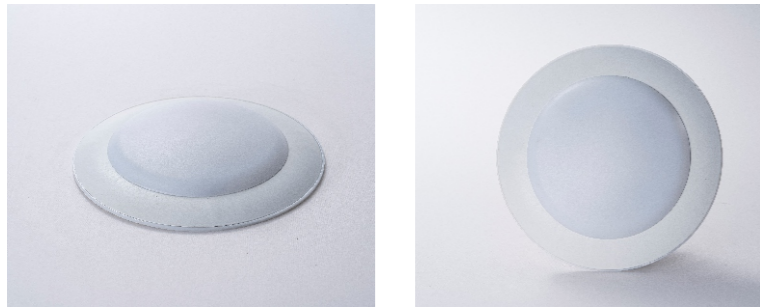

Work Hard Sleep Tight Easily transition from daytime illumination to a soothing night light glow



## SIZE & MODELS

6"  
1000lumens

## COLOR TEMPERATURE

5CCT / 3CCT / Single night light

\*Available in a 110-130V option (0-10v dim)

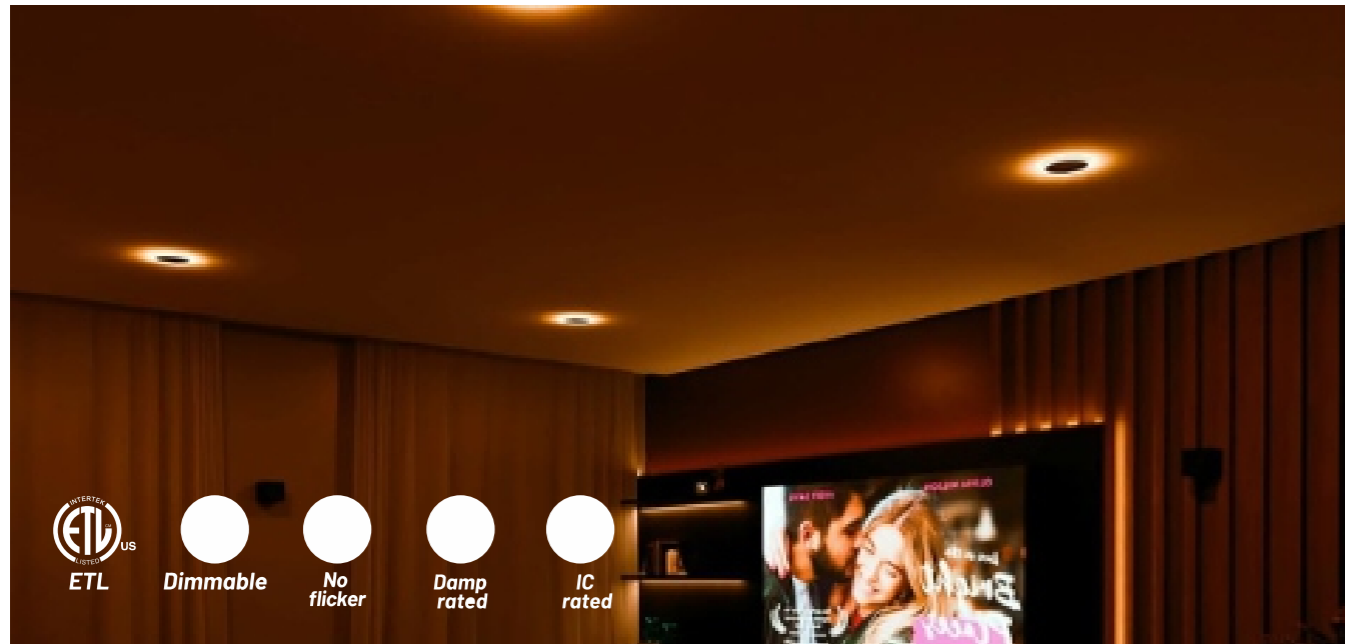

## Easy Installation

Recessed / Surface / Can Installation

### Option 1: Junction Box

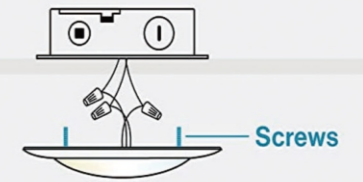
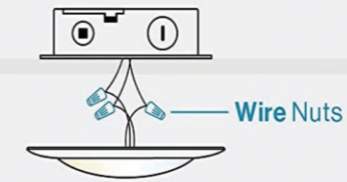

### Option 2: Recessed Can (TP24)

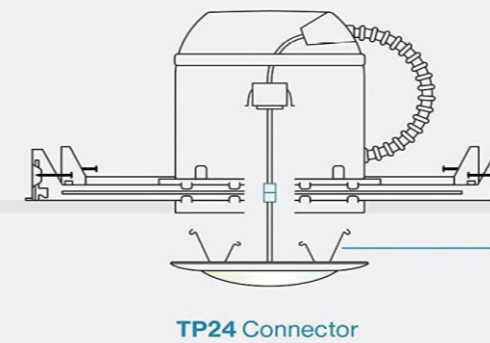

### Option 3: Recessed Can (E26)

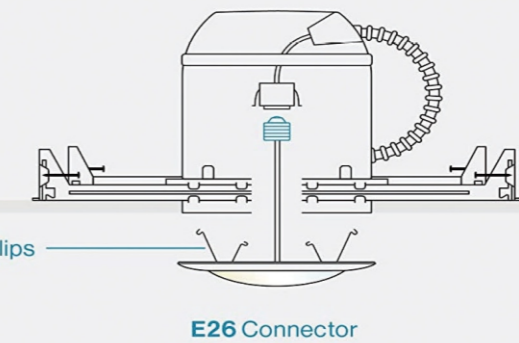

MODEL-NO	HS-AO-001
Watt	15W+3W
Size	198mm
Cut out	152.4mm
Input Voltage	110-130V
PF	>0.9
Dimmable	5CCT
Certincation	ETL/FCC
LED	SMD2835
Lumen	880Lm
CCT	Cip swich 5CCT/Single cct(2700-5000k)
CRI	>80/>90

## HS-FH PANEL LAMP

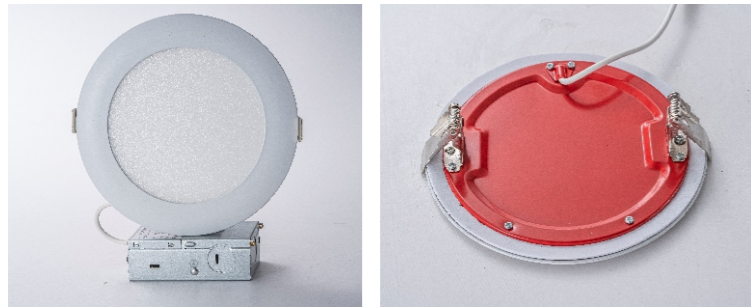

Elevate your lighting game with Low Profile LED Downlights 2 Hour Fire Rated, where superior craftsmanship meets innovation. Built with materials like die-cast aluminum, an IC Rated Jbox, Water Resistant connectors, Steel Clips, and a non-yellowing acrylic lens;

## SIZE & MODELS

3"	4"	6"	8"
460lumens	750lumens	940lumens	1530lumens

## COLOR TEMPERATURE

5CCT / 3CCT / Single

\*Available in a 110-130V option (0-10v dim)



## Easy Installation

Recessed / Can Installation

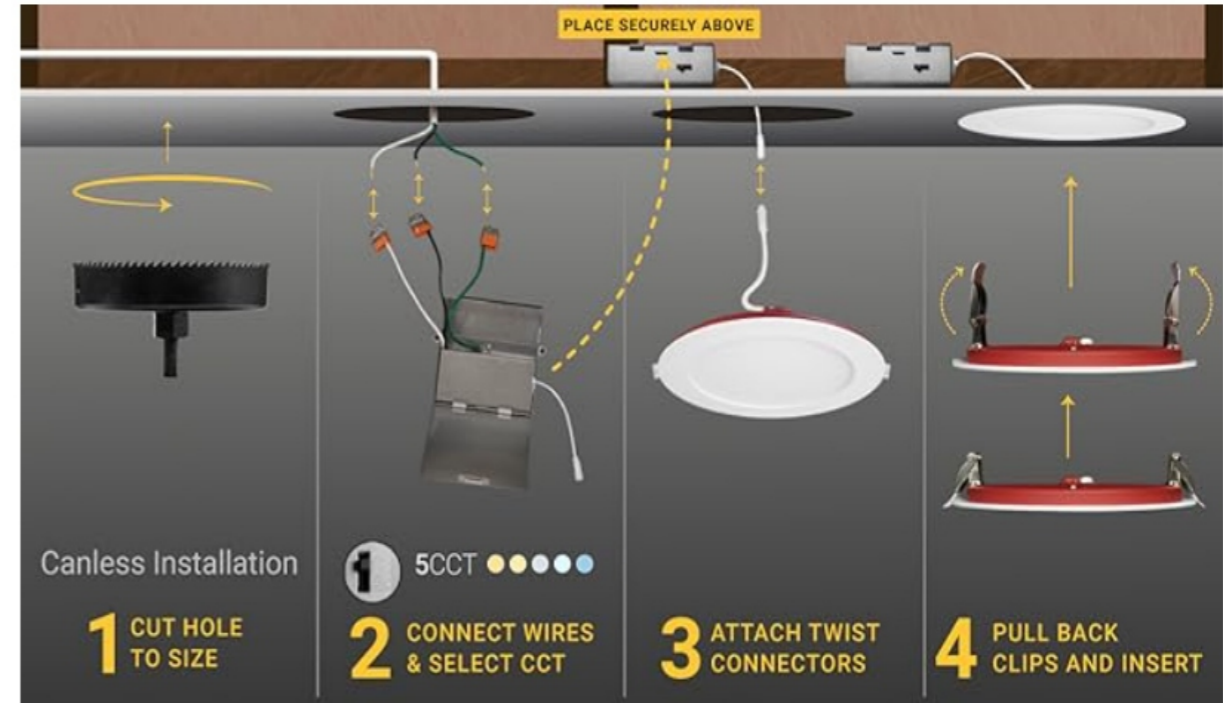

MODEL-NO	HS-FH-001	HS-FH-002	HS-FH-003	HS-FH-004
Watt	8W	9W	12W	18W
Size	90mm	130mm	180mm	230mm
Cut out	75mm	112mm	160mm	210mm
Input Voltage	110-130V	110-130V	110-130V	110-130V
PF	>0.9	>0.9	>0.9	>0.9
Dimmable	5CCT	5CCT	5CCT	5CCT
Certincation	ETL/FCC	ETL/FCC	ETL/FCC	ETL/FCC
LED	SMD2835	SMD2835	SMD2835	SMD2835
Lumen	460Lm	750Lm	940Lm	1530Lm
CCT	Cip swich 5CCT/Single cct(2700-5000k)			
CRI	>80/>90			

## HS-SD-DOWNLIGHT



Canless Ultra Thin Wafer Recessed Lighting Downlight with Junction Box, Dimmable & 5 Color Temperature Selectable, 6W, Canless Ultra Thin Wafer Recessed Lighting Downlight with Junction Box, Dimmable & 5 Color Temperature Selectable

## SIZE & MODELS

2"  
280lumens

## COLOR TEMPERATURE

5CCT / 3CCT / Single

\*Available in a 110-130V option (0-10v dim)

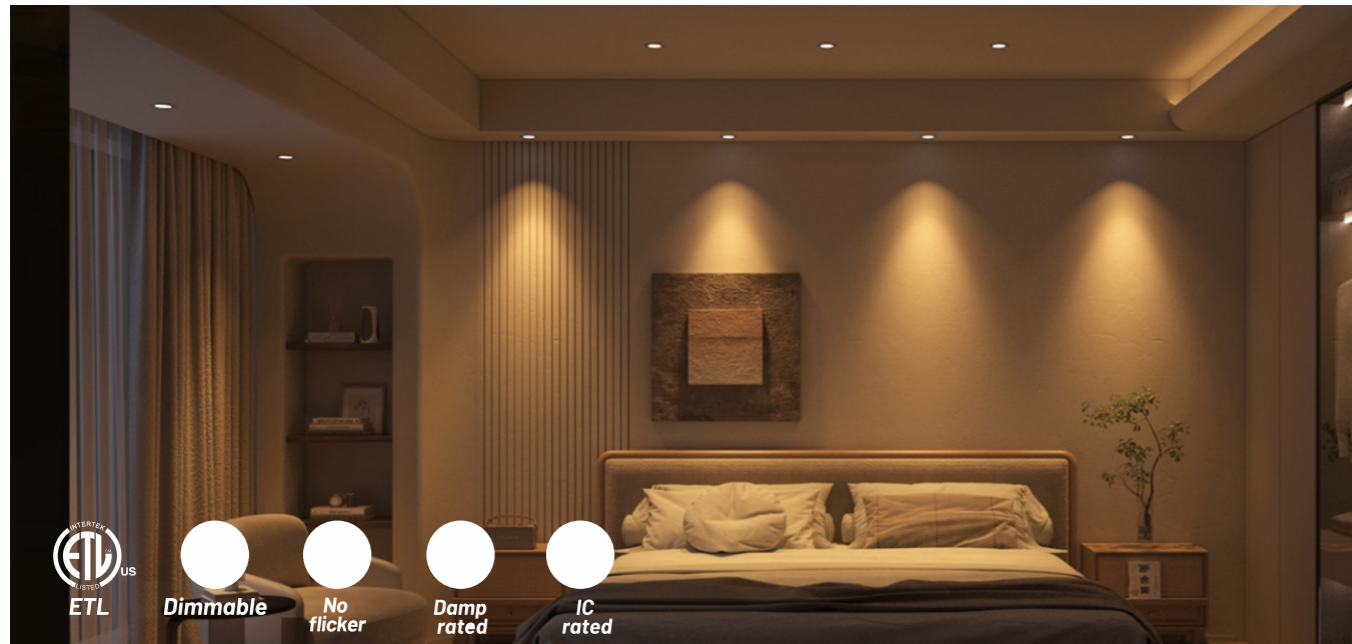

Dimmable

No flicker

Damp rated

IC rated

## Easy Installation Recessed / Can Installation

**Step 1** Turn off the power before installation. Remove the existing fixture if applicable. Determine the location and necessary hole cutout diameter using the supplied table and cut the ceiling hole with the listed approximate diameter.

**HOLE SIZE**  
2 inch: 2.36" (60mm)



**Step 3** Insert J-Box through the mounting hole and secure it, connect the fixture power cable to the J-Box. Select lamp color desired with the CCT switch.

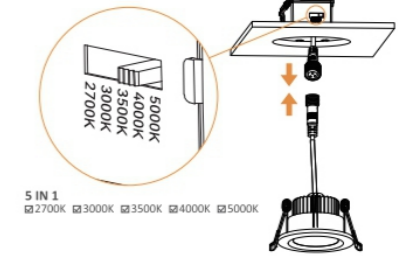

**Step 2** Open the J-Box cover and remove the appropriate knockout (s) on the side panel. Install the appropriate cable clamp (s) (not included) and insert the electrical supply cable through the cable clamp. Connect the supply wires to the fixture wires by using 3 connectors. Attach white to white, black to black, copper to the ground wire.

Black --- L  
White --- N  
Copper --- G

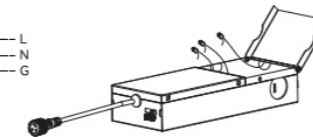

**Step 4** Push the spring-loaded clips into the mounting hole upwards and insert the fixture into it. Release the clips and the fixture will be pulled flush to the ceiling.

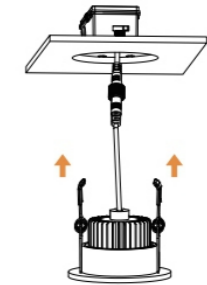

MODEL-NO	HS-AB-001
Watt	6W
Size	70mm
Cut out	55mm
Input Voltage	110-130V
PF	>0.9
Dimmable	5CCT
Certincation	ETL/FCC
LED	SMD2835
Lumen	280Lm
CCT	Cip swich 5CCT/Single cct(2700-5000k)
CRI	>80/>90